

image not found or type unknown http://zazzeri.thesecom.net/en/wp-content/uploads/2017/04/b3daf2\_357a



## Modern - Washbasin mixer on top

Codice kit: 3305 MLX-080

Washbasin mixer on top with ceiling-mounted washbasin spout

## Componenti



### Concealed part

Cod: 3300B110A00

Ceiling-mounted - concealed part

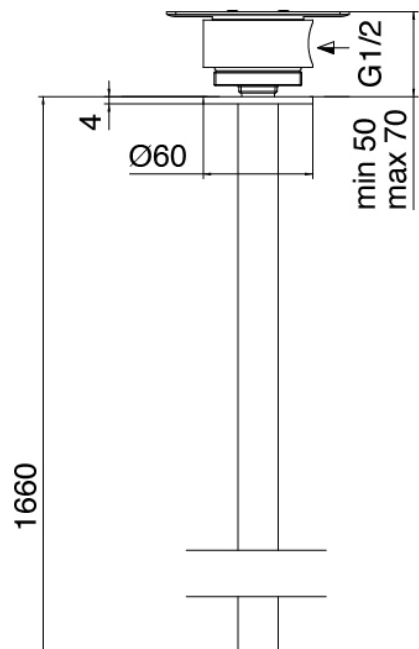



### Ceiling-mounted washbasin spout

Cod: 33000110A00

Ceiling-mounted washbasin spout

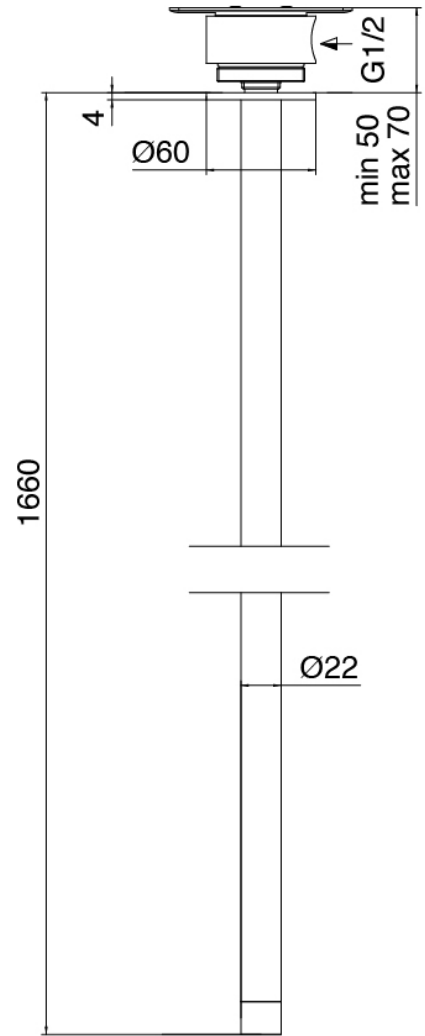

### Single-lever mixer

Cod: 3305M108A00

Surface single lever mixer - Ø36mm

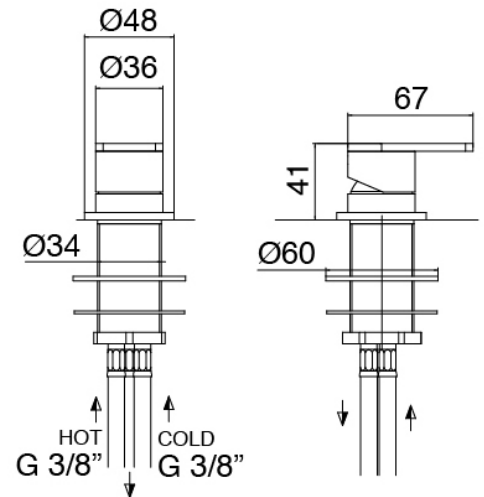



## Handle

Cod: 3305MA01A00

HANDLE MA01 Handle for washbasin/bidet mixer

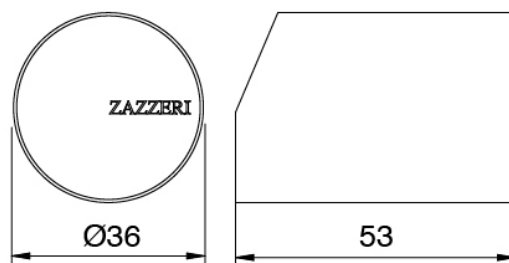

## Finiture disponibili:

finiture speciali su richiesta salvo quantitativi minimi di ordine garantiti



brush steel

ASAS

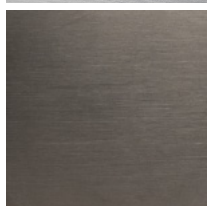

antracite

APAP

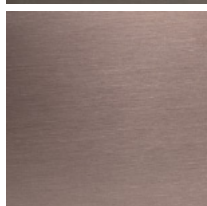

bronzorame

BPBP

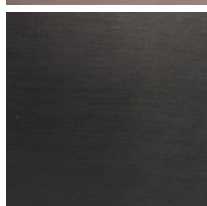

carbon

KPKP

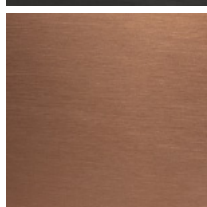

rame

RPRP

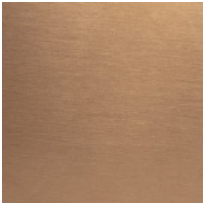

cognac

CPCP



orobianco

GPGP