



Modern - Braccio doccia con soffione, doccetta

Codice kit: 3101 DDI-080

Braccio doccia con soffione, doccetta e miscelatore a incasso – 2 uscite

Componenti

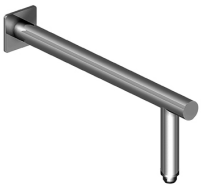

Braccio a parete

Cod: 3100BR01A00

Braccio doccia



Soffione doccia

Cod: 2900SO07A00

Soffione doccia Diam. 220 mm anticalcare -
Ispezionabile

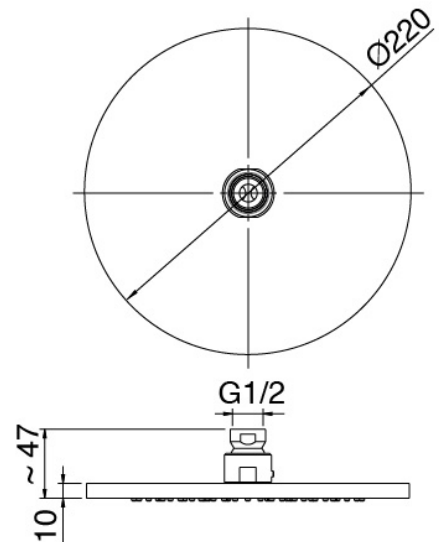



Doccetta stand alone

Cod: 31000413A00

Set doccetta con presa acqua e borchia tonda

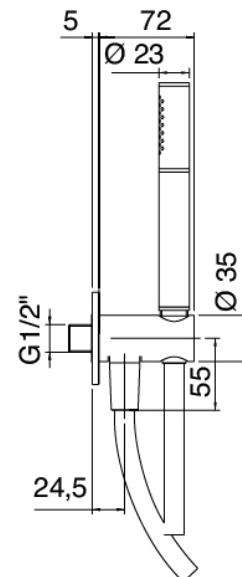
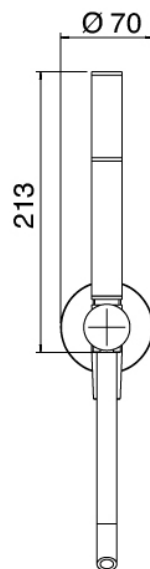

Miscelatore monocomando

Cod: 3101A401A00

Miscelatore doccia ad incasso con deviatore - parti esterne

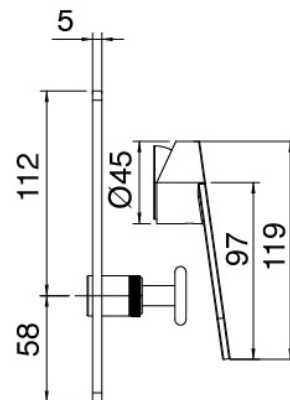
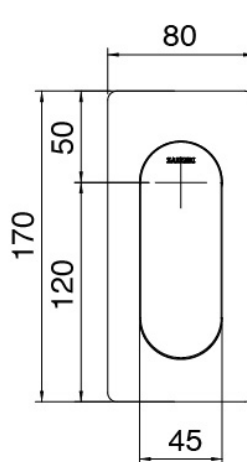

Parte grezza

Cod: 2900A401A00

Miscelatore doccia ad incasso con deviatore - parti grezze

Finiture disponibili:

finiture speciali su richiesta salvo quantitativi minimi di ordine garantiti

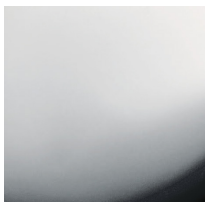

cromo

CRCR



acciaio spazzolato

NFNF



bianco

1010

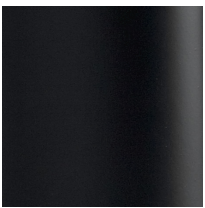

nero

3131