

SURF - Mitigeur lavabo a encastrer

Codice kit: 6300 MLI-050

Mitigeur lavabo a encastrer

Componenti



Partie brute

Cod: 2900B113A00

Mitigeur lavabo a encastrer - partie brute

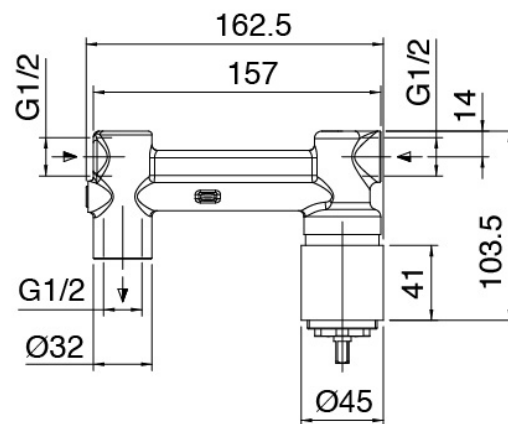

Finiture disponibili:

finiture speciali su richiesta salvo quantitativi minimi di ordine garantiti



chrome

CRCR



acier brossé

NFNF



blanc

1010



noir

3131

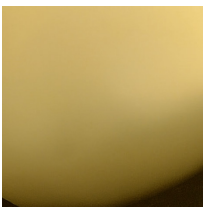

laiton brillant

OLOL