

Modern - Monomando lavabo de encimera

Codice kit: 3405 GLT-060

Monomando lavabo de encimera y cano lavabo de columna

Componenti



Parte basta

Cod: 3300B099A00

Lavabo de columna - pieza empontrada

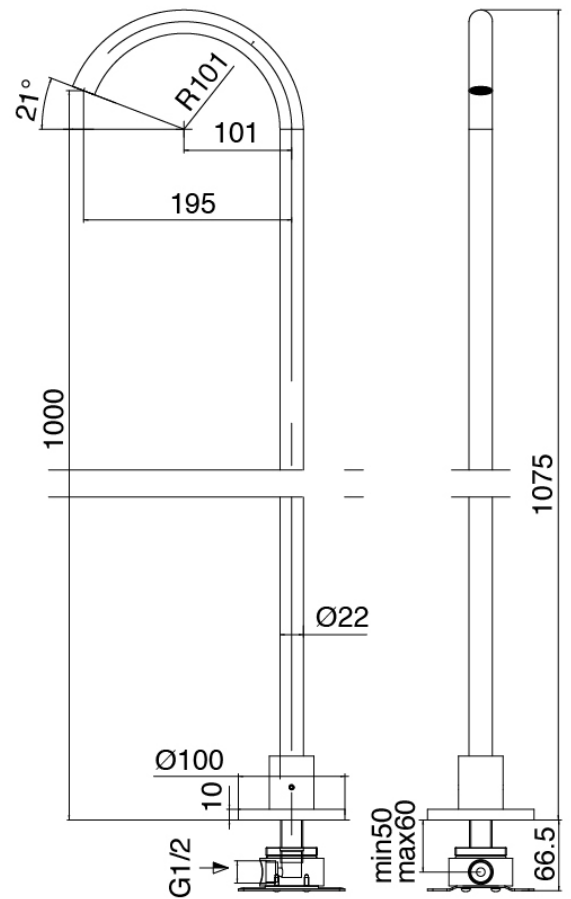



Maneta

Cod: 3305MA01A00

HANDLE MA01 Maneta para monomando lavabo/bide

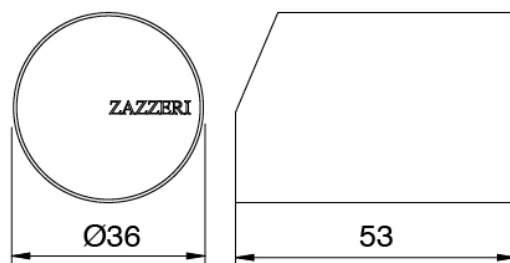

Finiture disponibili:

finiture speciali su richiesta salvo quantitativi minimi di ordine garantiti



acero satinado

ASAS

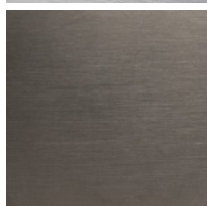

antracite

APAP

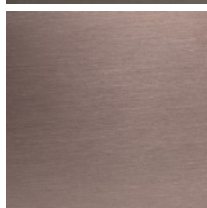

bronzorame

BPBP

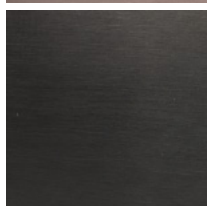

carbon

KPKP

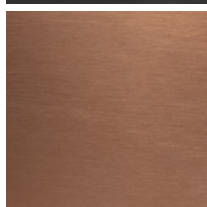

rame

RPRP



cognac

CPCP



orobianco

GPGP